



VTA12-5 (12V 5.0AH/20HR) F2 SEALED LEAD ACID Battery

VALIANT VTA series are designed with AGM technology and high-performance lead plates using 99.99% virgin lead. VTA is perfectly suited for backup power systems such as UPS, security, and emergency lighting systems. They are sealed maintenance free and valve regulated, also referred to as VRLA and SLA.

**12V
5Ah**

**AGM
Technology**



COMPLIED STANDARDS

**IEC 60896-21/22
YD/T799
GB/T 19638**

**JIS C8704
BS6290 part4
CE**

Applications

- UPS
- Emergency Lighting
- Electric Scooter
- Mobility

Dimensions & Weight

Length(mm/inch)	90/3.54
Width(mm/inch)	71/2.76
Height(mm/inch)	101/3.98
Total Height(mm/inch)	107/4.22
Weight(kg/lbs)(±3%)	1.58/3.53

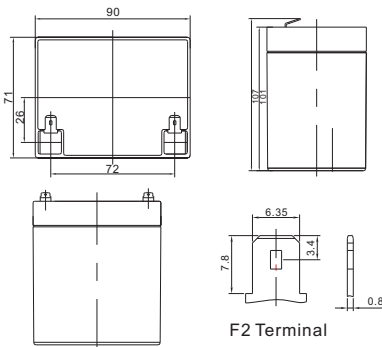

General Features

- Non-spillable construction design
- Long life span: 5-8 years in floating applications
- High Quality AGM separator: extends cycle life and prevents short circuit
- 99.99% virgin lead plates ensure high quality and high reliability
- Flame-resistant ABS material: increases the strength of battery container

Technical Specifications

Nominal Voltage		12V (6 cells per unit)
Design Floating Life @ 25°C		5 Years
Nominal Capacity @ 25°C	20 hour rate@0.25A,10.8V	5Ah
Capacity @ 25°C	10 hour rate (0.48A, 10.8V)	4.80Ah
	5 hour rate (0.89A, 10.5V)	4.45Ah
	1 hour rate (3.3A,9.6V)	3.3Ah
Internal Resistance	Full Charged Battery@ 25°C	≤30.0mΩ
Ambient Temperature	Discharge	-15°C~45°C
	Charge	-15°C~45°C
	Storage	-15°C~45°C
Max.Discharge Current		@ 25°C 30A(5s)
Capacity affected by Temperature (10 hour)	40°C	105%
	25°C	100%
	0°C	85%
	-15°C	65%
Self-Discharge@25°C per Month		3%
Charge (Constant Voltage) @ 25°C	Standby Use	Initial Charging Current Less than 1.5A Voltage 13.6-13.8V
	Cycle Use	Initial Charging Current Less than 1.5A Voltage 14.4-14.9V

Battery Discharge Table

Discharge Constant Current per Cell (Amperes at 25°C)

F.V/Time	15min	30min	45min	1h	2h	3h	5h	8h	10h	20h
1.60V	8.28	5.50	3.85	3.30	2.06	1.41	0.94	0.63	0.52	0.28
1.65V	8.13	5.40	3.78	3.24	2.03	1.39	0.93	0.62	0.51	0.27
1.70V	7.98	5.30	3.71	3.18	1.99	1.36	0.91	0.61	0.50	0.27
1.75V	7.83	5.20	3.64	3.12	1.95	1.34	0.89	0.60	0.49	0.26
1.80V	7.52	5.00	3.50	3.00	1.88	1.28	0.86	0.58	0.48	0.25

Discharge Constant Power per Cell (Watts at 25°C)

F.V/Time	15min	30min	45min	1h	2h	3h	5h	8h	10h	20h
1.60V	15.93	10.59	7.41	6.35	3.97	2.72	1.81	1.22	1.01	0.53
1.65V	15.64	10.40	7.28	6.24	3.90	2.67	1.78	1.20	0.99	0.52
1.70V	15.35	10.20	7.14	6.12	3.83	2.62	1.75	1.18	0.97	0.51
1.75V	15.06	10.01	7.01	6.01	3.75	2.57	1.72	1.15	0.95	0.50
1.80V	14.48	9.63	6.74	5.78	3.61	2.47	1.65	1.11	0.92	0.48



Performance Characteristics

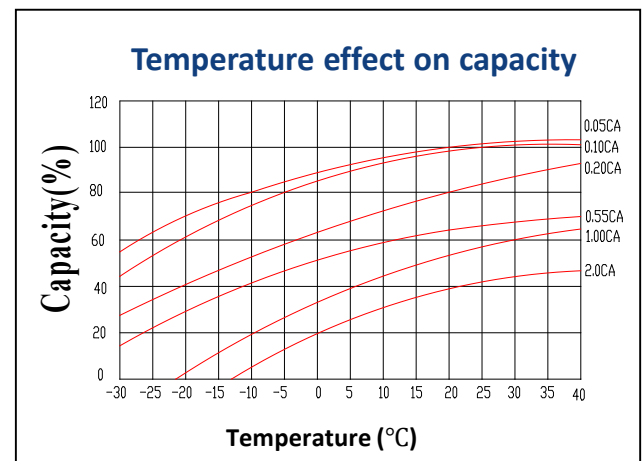
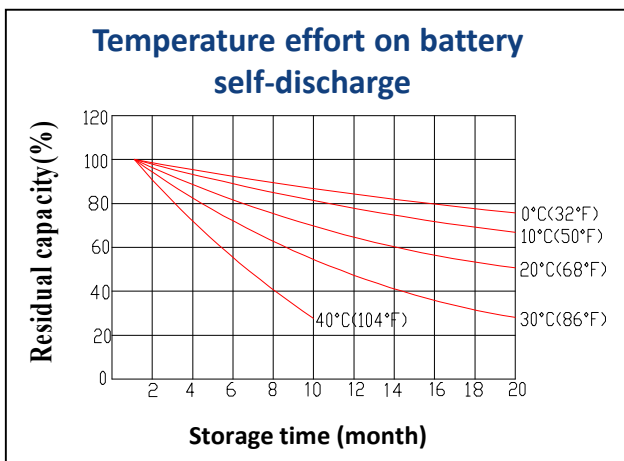
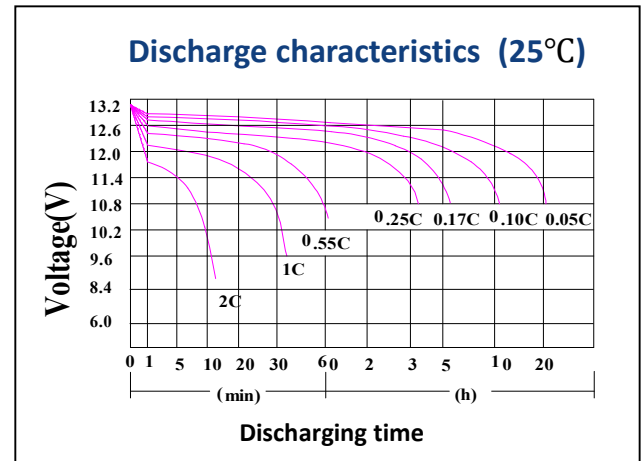
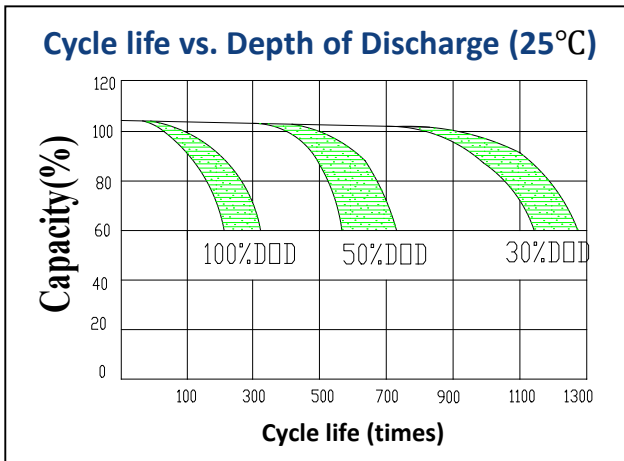
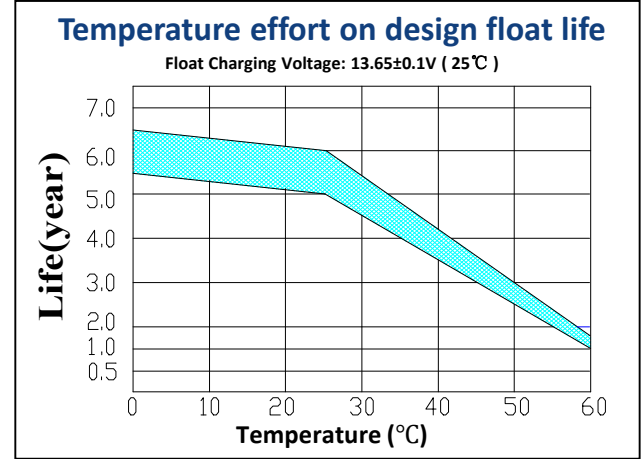
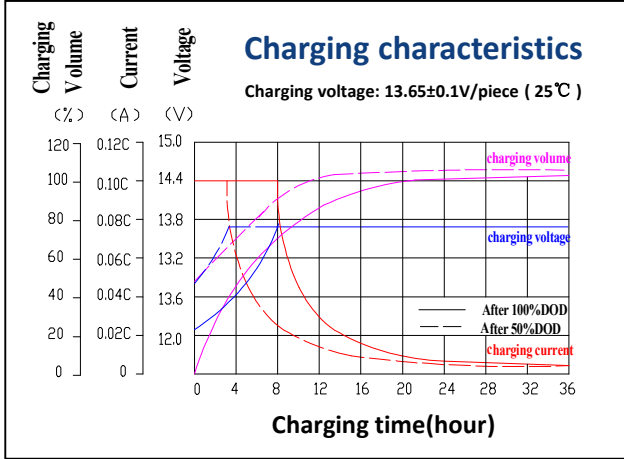

Battery Construction

Component	Positive Plate	Negative Plate	Container & Cover	Safety Valve	Terminal	Separator	Electrolyte	Pillar Seal
Features	Thick high Sn low Ca grid with special paste	Balanced Pb-Ca grid for improved recombination efficiency	ABS (UL94-VO optional)	Flame Si-Rubber and aging resistant	F2	Advanced AGM separator for high pressure cell design	Dilute high purity sulfuric acid	Two layers epoxy resin seal