



VFT12-175 (12V 175AH/10HR) Nonspillable VRLA Battery

VALIANT VFT Series is specially designed for telecom use with 8-10 year design life in float service. By adopting a new AGM separator and centralized venting system, the battery can be installed in any position while maintaining high reliability. The dimensions of the VFT series are designed for 19" and 23" cabinet installation. It is suitable for telecom EPS, applications.

**12V
175Ah**

**AGM
Technology**

**Telecom
Battery**



COMPLIED STANDARDS

**IEC 60896-21/22 JIS C8704
YD/T799 BS6290 part4
GB/T 19638 CE**

Applications

- Telecom Control Equipment
- UPS systems, Inverter
- Power Equipment
- Solar & Wind
- Emergency Power Systems

General Features

- Advanced AGM technology, and Maintenance-free operation
- Front access terminal with standard width for 19" and 23" ETSI racks
- Fire resistant ABS container
- Long float service life 10 years
- Low self discharge < 3%.

Dimensions & Weight

Length(mm/inch)	546/21.5
Width(mm/inch)	125/4.92
Height(mm/inch)	321/12.64
Total Height(mm/inch)	321/12.64
Weight(kg/lbs)(±3%)	53.7/118.3

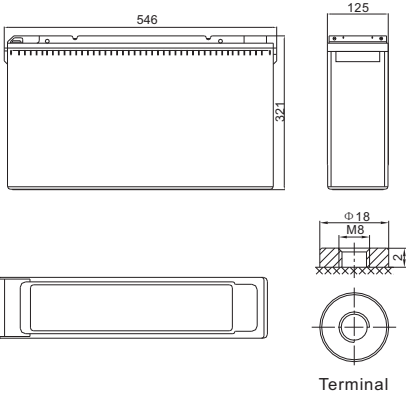

Technical Specifications

Nominal Voltage		12V (6 cells per unit)
Design Floating Life @ 25°C		10 Years
Nominal Capacity @ 25°C	10 hour rate@17.5A,10.8V	175Ah
Capacity @ 25°C	20 hour rate (9.28A, 10.8V)	185.6Ah
	5 hour rate (30.8A, 10.5V)	154.0Ah
	1 hour rate (111.7A, 9.6V)	111.7Ah
Internal Resistance	Full Charged Battery@ 25°C	≤3.0mΩ
Ambient Temperature	Discharge	-15°C ~ 45°C
	Charge	-15°C ~ 45°C
	Storage	-15°C ~ 45°C
Max.Discharge Current @ 25°C		1050A (5s)
Capacity affected by Temperature (10 hours)	40°C	105%
	25°C	100%
	0°C	85%
	-15°C	65%
Self-Discharge@25°C per Month		3%
Charge (Constant Voltage) @ 25°C	Standby Use	Initial Charging Current Less than 43.0A Voltage 13.6-13.8V
	Cycle Use	Initial Charging Current Less than 43.0A Voltage 14.4-14.9V

Battery Discharge Table

Discharge Constant Current per Cell (Amperes at 25°C)

F.V/Time	10min	15min	30min	45min	1h	2h	3h	5h	8h	10h	20h
1.60V	406.9	315.9	189.5	140.9	111.7	65.6	48.3	32.6	22.2	18.4	9.71
1.65V	376.4	298.4	183.2	135.5	108.3	63.5	46.7	32.0	22.1	18.0	9.63
1.70V	349.1	280.2	178.2	130.6	104.1	61.8	45.5	31.3	21.7	17.9	9.52
1.75V	326.0	262.5	168.9	124.8	99.9	60.2	44.5	30.8	21.4	17.7	9.43
1.80V	293.3	246.2	162.9	120.2	96.4	57.9	43.1	30.1	21.0	17.5	9.28

Discharge Constant Power per Cell (Watts at 25°C)

F.V/Time	10min	15min	30min	45min	1h	2h	3h	5h	8h	10h	20h
1.60V	731.9	603.9	369.4	267.6	214.2	124.4	92.2	62.8	43.4	35.9	18.7
1.65V	685.0	577.9	353.3	258.5	208.4	121.1	89.8	61.8	43.1	35.5	18.6
1.70V	641.4	538.5	338.8	250.3	201.3	118.3	87.7	60.9	42.5	35.2	18.4
1.75V	603.6	505.2	322.5	240.3	193.9	115.5	85.9	60.0	42.0	34.8	18.2
1.80V	546.4	474.3	309.4	232.2	187.6	111.7	83.5	58.8	41.5	34.7	18.0



Performance Characteristics

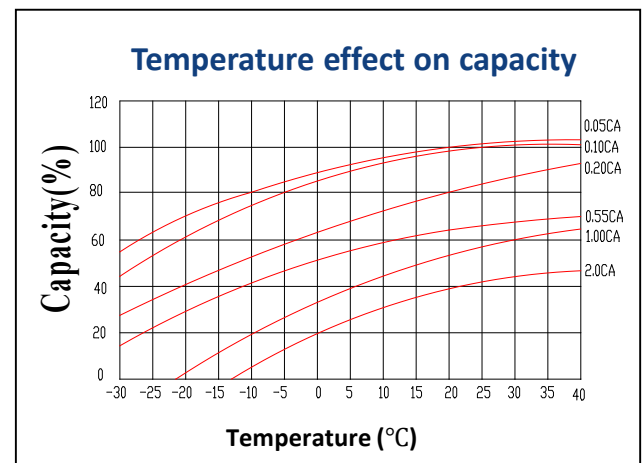
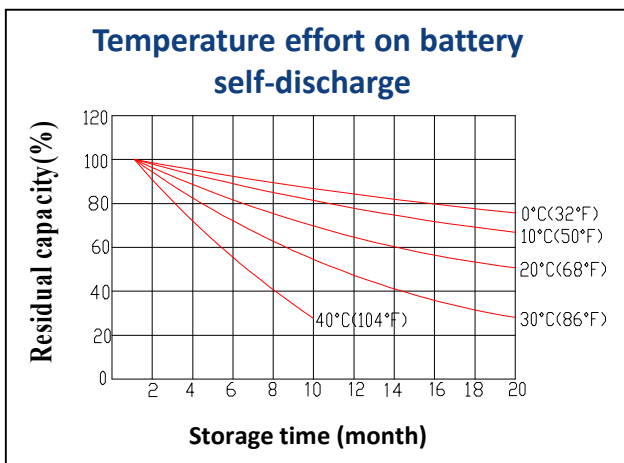
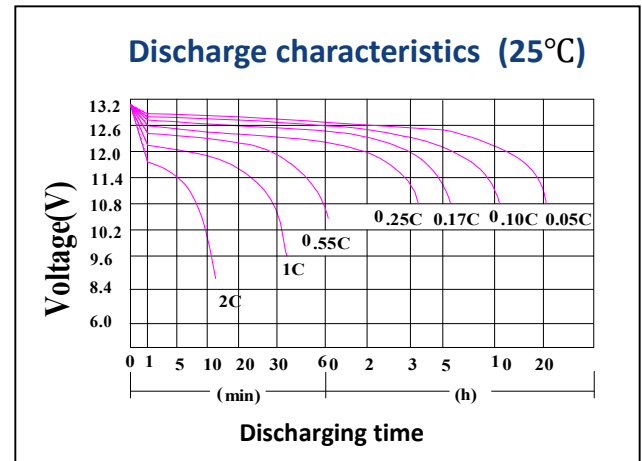
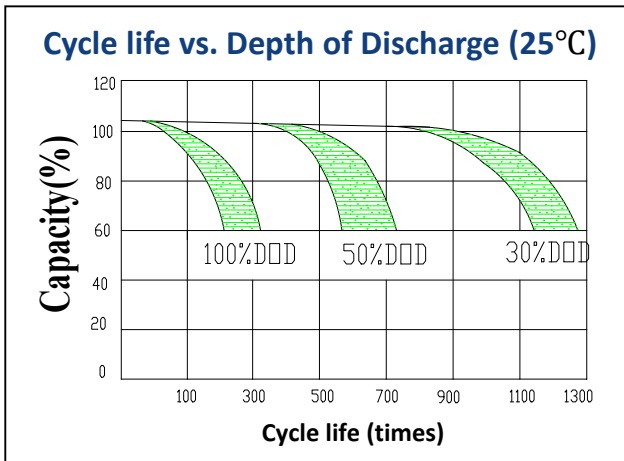
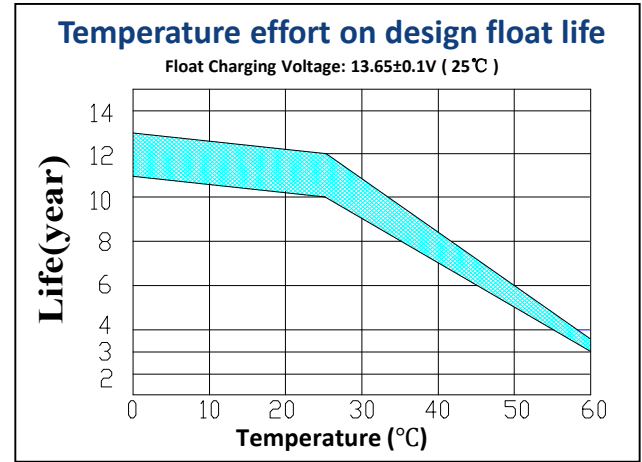
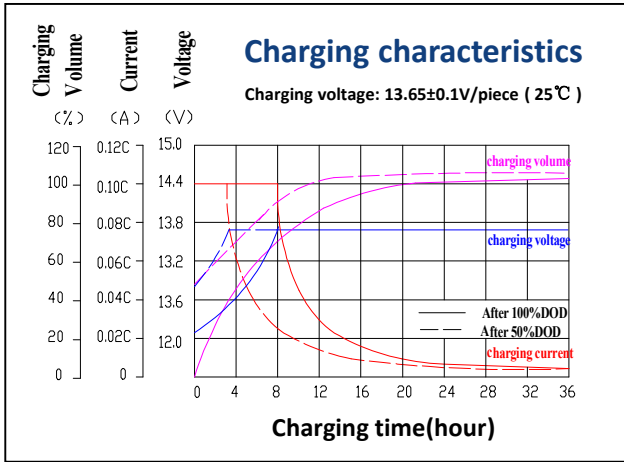

Battery Construction

Component	Positive Plate	Negative Plate	Container & Cover	Safety Valve	Terminal	Separator	Electrolyte	Pillar Seal
Features	Thick high Sn low Ca grid with special paste	Balanced Pb-Ca grid for improved recombination efficiency	Fire resistant ABS (UL94-V0 optional)	Flame Si-Rubber and aging resistant	Female Copper Insert M8	Advanced AGM separator for high pressure cell design	Dilute high purity sulfuric acid	Two layers epoxy resin seal