



VTG12-14 (12V 14AH/20HR) High Temperature Deep Cycle GEL Battery

The Valiant VTG series deep cycle Gel battery uses an advanced nano gel electrolyte with Super-C additive and heavy-duty plate design to provide longer service life in deep cycle applications. The VTG series provides optimum and reliable service under extreme temperatures and frequent power failures making it highly suited for out door applications such as off-grid solar systems, RV, and telecom/UPS systems.

**12V
14Ah**

**GEL
Technology**

**Deep
Cycle**



Applications

- UPS
- Emergency Lighting
- Electric Scooter
- Mobility

General Features

- Operating range of -40 to+ 60 °C
- Deep discharge recovery,1600 cycles @50%DOD
- 2-3 year full warranty in most applications
- Longer life and greater stability in extreme temperatures

Dimensions & Weight

Length(mm/inch)	152/5.98
Width(mm/inch)	99/3.90
Height(mm/inch)	96/3.78
Total Height(mm/inch)	102/4.02
Weight(kg/lbs)(±3%)	3.8/8.40

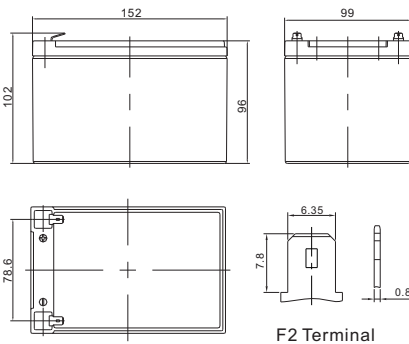

Battery Discharge Table

Technical Specifications

Nominal Voltage		12V (6 cells per unit)
Design Floating Life @ 25°C		8 Years
Nominal Capacity @ 25°C	20 hour rate@ 0.7A, 10.8V	14Ah
Capacity @ 25°C	10 hour rate (1.26A, 10.8V)	12.6Ah
	5 hour rate (2.3A, 10.5V)	11.5Ah
	1 hour rate (8.5A, 9.6V)	8.5Ah
Internal Resistance	Full Charged Battery@ 25°C	≤15.0mΩ
Ambient Temperature	Discharge	-25°C ~ 45°C
	Charge	-25°C ~ 45°C
	Storage	-25°C ~ 45°C
Max.Discharge Current		@ 25°C 84A(5s)
Capacity affected by Temperature (10 hour)	40°C	108%
	25°C	100%
	0°C	90%
	-15°C	70%
Self-Discharge@25°C per Month		3%
Charge (Constant Voltage) @ 25°C	Standby Use	Initial Charging Current Less than 3.6A Voltage 13.6-13.8V
	Cycle Use	Initial Charging Current Less than 3.6A Voltage 14.4-14.9V



COMPLIED STANDARDS
IEC 60896-21/22 **JIS C8704**
YD/T799 **BS6290 part4**
GB/T 19638 **CE**

Discharge Constant Current per Cell (Amperes at 25°C)

F.V/Time	15min	30min	45min	1h	2h	3h	5h	8h	10h	20h	100h
1.60V	23.2	15.4	10.8	8.5	5.2	4.0	2.5	1.8	1.39	0.77	23.2
1.65V	22.8	15.1	10.6	8.3	5.1	3.9	2.4	1.7	1.36	0.76	22.8
1.70V	22.3	14.8	10.4	8.2	5.0	3.8	2.4	1.7	1.34	0.74	22.3
1.75V	21.9	14.6	10.2	8.0	5.0	3.7	2.3	1.7	1.31	0.73	21.9
1.80V	21.1	14.0	9.8	7.7	4.8	3.6	2.2	1.6	1.26	0.70	21.1

Discharge Constant Power per Cell (Watts at 25°C)

F.V/Time	15min	30min	45min	1h	2h	3h	5h	8h	10h	20h	100h
1.60V	44.6	29.6	20.8	16.3	10.1	7.6	4.8	3.4	2.7	1.5	44.6
1.65V	43.8	29.1	20.4	16.0	9.9	7.5	4.7	3.4	2.6	1.5	43.8
1.70V	43.0	28.6	20.0	15.7	9.7	7.3	4.6	3.3	2.6	1.4	43.0
1.75V	42.2	28.0	19.6	15.4	9.5	7.2	4.5	3.2	2.5	1.4	42.2
1.80V	40.6	27.0	18.9	14.8	9.2	6.9	4.4	3.1	2.4	1.3	40.6



Performance Characteristics

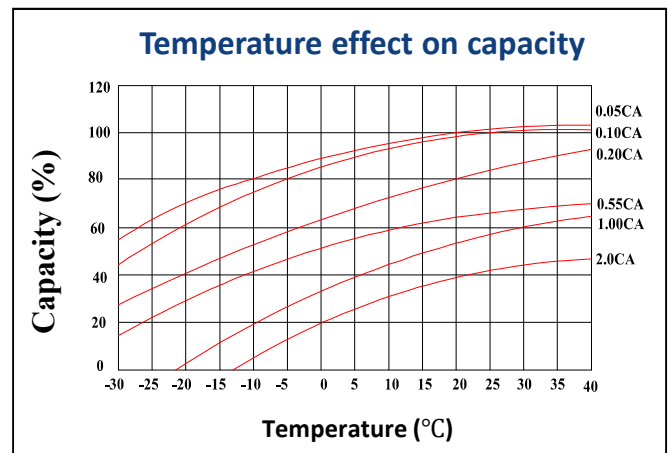
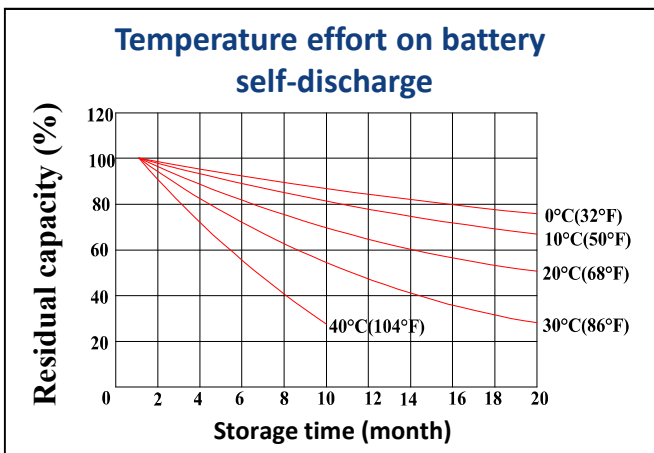
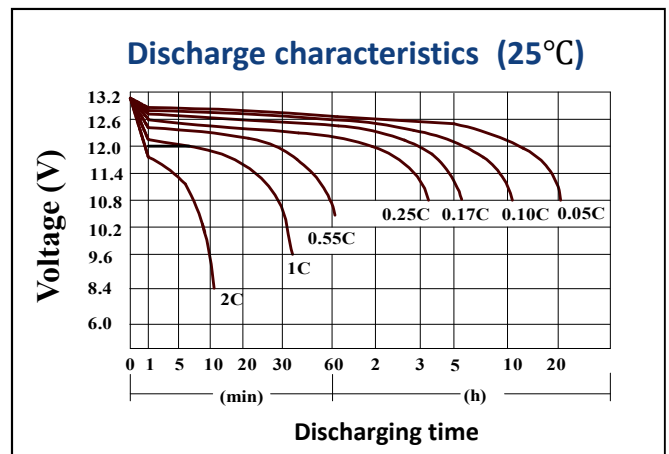
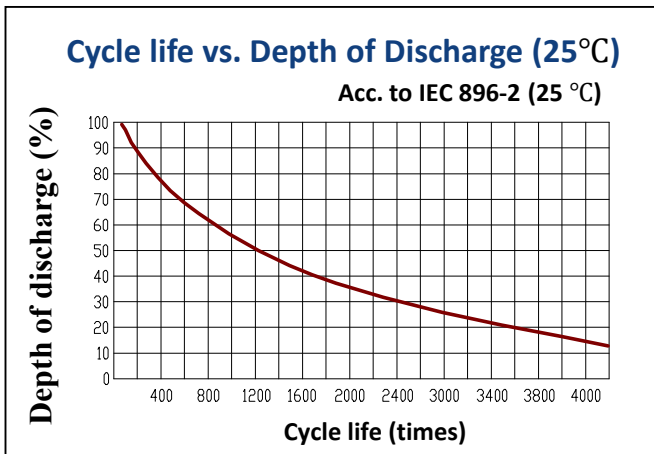
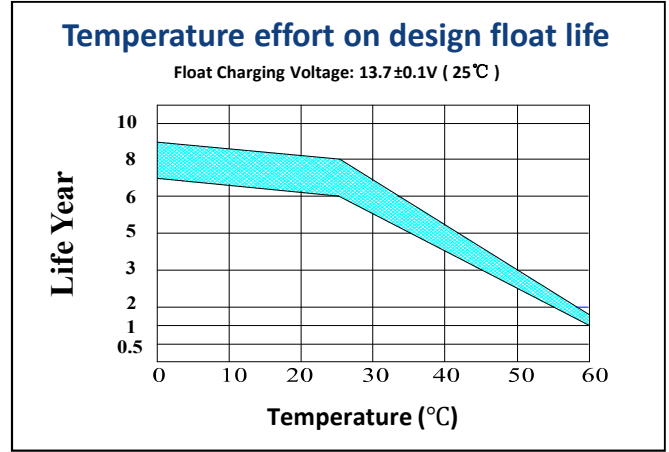
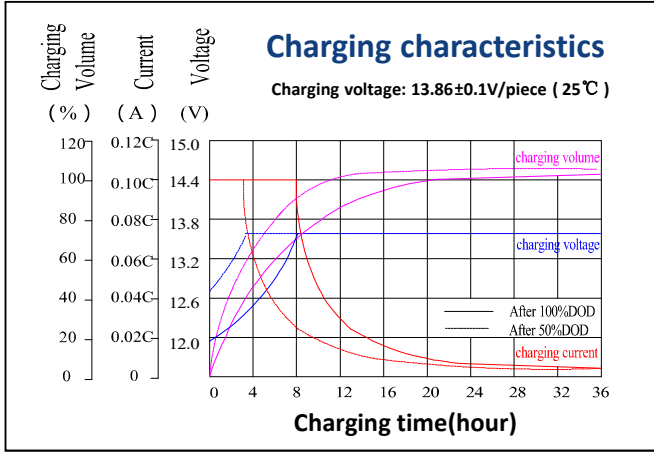

Battery Construction

Component	Positive Plate	Negative Plate	Container & Cover	Safety Valve	Terminal	Separator	Electrolyte	Pillar Seal
Features	Thick high Sn low Ca grid with special paste	Balanced Pb-Ca grid for improved recombination efficiency	Fire resistant ABS (UL94-V0 optional)	Flame Si-Rubber and aging resistant	F2	Advanced AGM separator for high pressure cell design	Silicon Gel	Two layers epoxy resin seal